

ISDM Series

8.4" ~ 19" Stainless Steel TFT LCD Monitor



ISDM-190G



Best solution for food, chemical and pharmaceutical industries

Stainless steel can resist corrosion in most acids, alkaline solutions, and chlorine bearing environments, properties which are utilized in process plants. In addition, the easy cleaning ability makes it the first choice for strict hygiene conditions, such as hospitals, kitchens, abattoirs and other food processing plants.

ISDM Stainless Steel Monitor



Stainless Steel Front Panel

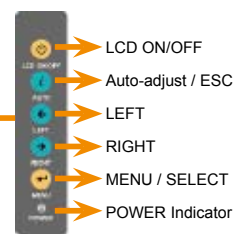
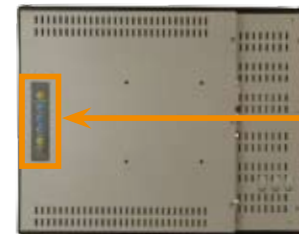

Full function OSD keys in back panel

Features

1. Stainless Steel chassis & bezel features corrosion resistance and hygienic properties
2. Full function OSD keys in back panel to help customers easy to control
3. IP 65 compliant front panel

Specifications

Note: The smartOSD function is supported by revision 11 models and above

Model	ISDM-084GH-R11	ISDM-104GH-R11	ISDM-121G-R11	ISDM-150G-R11	ISDM-170G-R11	ISDM-190G-R11
LCD Size	8.4" TFT	10.4" TFT	12.1" TFT	15" TFT	17" TFT	19" TFT
Input Interface	Analog VGA			Analog VGA + DVI-D		
Max Resolution	800 x 600	800 x 600	800 x 600 / 1024 x 768	1024 x 768	1280 x 1024	1280 x 1024
Brightness (cd/m ²)	400	400	400 / 450	350	300	300
Contrast	400 : 1	500 : 1	500 : 1 / 700 : 1	400 : 1	500 : 1	700 : 1
LCD Color	262K	262K	262K	262K	16.2M	16.2M
Pixel Pitch (mm)	0.213	0.264	0.3075 / 0.240	0.297	0.264	0.294
Front Frame	Stainless Steel					
Chassis	Heavy-Duty Steel					
View Angle (H/V)	120/100	120/100	140/110 / 160/160	120/100	140/130	140/130
Power Adapter	25W 63000-UP0251E12PL02-RS			45W 63000-UP0451E12P81L-RS		
OSD function	YES					
Smart OSD	YES					
Mounting	Stand / Panel / Wall / Arm (100x100)					
Back Cover Color	Silver					
Dimension (WxHxD) (mm)	244 x 178 x 49	311.5 x 242 x 52.1	340 x 260 x 58	409.25x 308.25 x 63.2	452 x 356 x 63.2	482.6 x 399.3 x 71.6
Operation Temperature (°C)	0~50°C					
IP Level	IP 65					
Net Weight	2.3 kg	3.4 kg	4.4 kg	6.6 kg	9.2 kg	10.75 kg

Mounting Kits Information

	ISDM-84G	ISDM-104G	ISDM-121G	ISDM-150G	ISDM-170G	ISDM-190G
Panel Mount Kits	PK-84M	PK-104M		PK-170M		PK-190M
Wall Mount Kits				WK-190MS-R10		
Rack Mount Kits				N/A		
Din Mount Kits				N/A		
LCD Monitor Arm		ARM-11			ARM-31	
LCD Monitor Stand		STAND-100-RS/STAND-150-RS			STAND-210-RS	

Ordering Information

Note: The smartOSD function is supported by revision 11 models and above

Part No.	Description	
8.4"	ISDM-084GHM-R11/T-R 8.4" 400cd/m ² High Luminance SVGA LCD Monitor with VGA and 9~36V DC Input, Stainless Steel Front Panel,W/8.4" Touch Screen,RoHS	
	ISDM-084GH-R11/T-R 8.4" 400cd/m ² High Luminance SVGA LCD Monitor with VGA, Stainless Steel Front Panel,W/8.4" Touch Screen,RoHS	
10.4"	ISDM-104GH-R11/T-R 10.4" 400cd/m ² High Luminance SVGA LCD Monitor with VGA, Stainless Steel Front Panel,W/10.4" Touch Screen,RoHS	
	ISDM-104GHM-R11/T-R 10.4" 400cd/m ² High Luminance SVGA LCD Monitor with VGA and 9~36V DC Input, Stainless Steel Front Panel,W/10.4" Touch Screen,RoHS	
12.1"	ISDM-121G-R11/T-R 12.1" 400cd/m ² SVGA LCD Monitor, Stainless Steel Front Panel,W/12.1" Touch Screen, RoHS	
	ISDM-121GM-R11/T-R 12.1" 400cd/m ² SVGA LCD Monitor, Stainless Steel Front Panel,W/12.1" Touch Screen, 9~36V DC input, RoHS	
	ISDM-121G-USB-R11/T-R 12.1" 400cd/m ² SVGA LCD Monitor, Stainless Steel Front Panel,W/12.1" USB Touch Screen, RoHS	
	ISDM-121GM-USB-R11/T-R 12.1" 400cd/m ² SVGA LCD Monitor, Stainless Steel Front Panel,W/12.1" USB Touch Screen, 9~36V DC input, RoHS	
	ISDM-121GX-R11/T-R 12.1" 450cd/m ² XGA LCD Monitor, Stainless Steel Front Panel,W/12.1" Touch Screen, RoHS	
	ISDM-121GXM-R11/T-R 12.1" 450cd/m ² XGA LCD Monitor, Stainless Steel Front Panel,W/12.1" Touch Screen,9~36V DC input, RoHS	
	ISDM-121GX-USB-R11/T-R 12.1" 450cd/m ² XGA LCD Monitor, Stainless Steel Front Panel,W/12.1" USB Touch Screen, RoHS	
	ISDM-121GXM-USB-R11/T-R 12.1" 450cd/m ² XGA LCD Monitor, Stainless Steel Front Panel,W/12.1" USB Touch Screen,9~36V DC input, RoHS	
	15"	ISDM-150G-R11/T-R 15" 350cd/m ² XGA LCD Monitor, Stainless Steel Front Panel,W/15" Touch Screen,RoHS
		ISDM-150GM-R11/T-R 15" 350cd/m ² XGA LCD Monitor, Stainless Steel Front Panel,W/15" Touch Screen,9~36V DC input,RoHS
		ISDM-150G-USB-R11/T-R 15" 350cd/m ² XGA LCD Monitor, Stainless Steel Front Panel,W/15" USB Touch Screen,RoHS
		ISDM-150GM-USB-R11/T-R 15" 350cd/m ² XGA LCD Monitor, Stainless Front Panel,W/15" USB Touch Screen,9~36V DC input,RoHS
17"	ISDM-170G-R11/T-R 17" 300cd/m ² SXGA LCD Monitor, Stainless Front Panel,W/17" Touch Screen,,RoHS	
	ISDM-170GM-R11/T-R 17" 300cd/m ² SXGA LCD Monitor, Stainless Front Panel,W/17" Touch Screen,9~36V DC input,RoHS	
	ISDM-170G-USB-R11/T-R 17" 300cd/m ² SXGA LCD Monitor, Stainless Front Panel,W/17" USB Touch Screen,RoHS	
	ISDM-170GM-USB-R11/T-R 17" 300cd/m ² SXGA LCD Monitor, Stainless Front Panel,W/17" USB Touch Screen,9~36V DC input,RoHS	
19"	ISDM-190G-R11/T-R 19" 300cd/m ² SXGA LCD Monitor with VGA and DVI-D input, Stainless Steel Front Panel,Silver Color,W/19" Touch Screen,RoHS	
	ISDM-190GM-R11/T-R 19" 300cd/m ² SXGA LCD Monitor with VGA and DVI-D input and 9~36V DC Input, Stainless Steel Front Panel,W/19" Touch Screen,RoHS	
	ISDM-190G-USB-R11/T-R 19" 300cd/m ² SXGA LCD Monitor with VGA and DVI-D input, Stainless Steel Front Panel,W/19" USB Touch Screen,RoHS	
	ISDM-190GM-USB-R11/T-R 19" 300cd/m ² SXGA LCD Monitor with VGA and DVI-D input and 9~36V DC Input, Stainless Steel Front Panel, W/19" USB Touch Screen,RoHS	



Dimensions

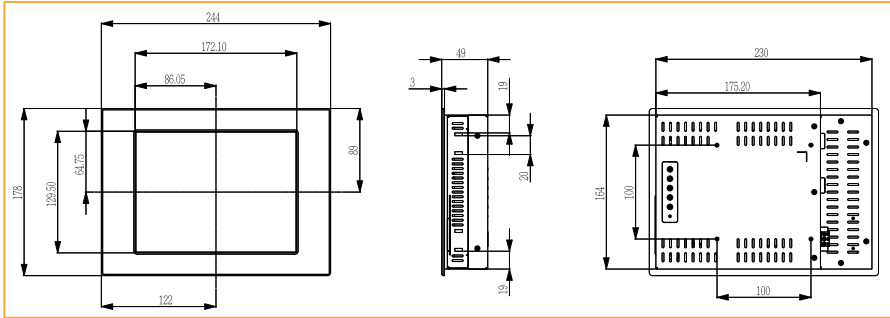

ISDM-84GH

ISDM-104G

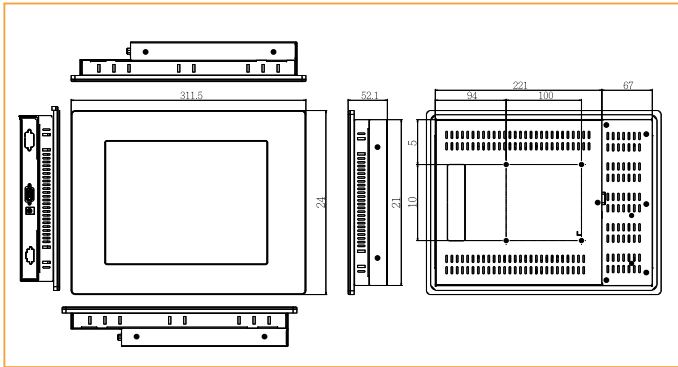

ISDM-121G

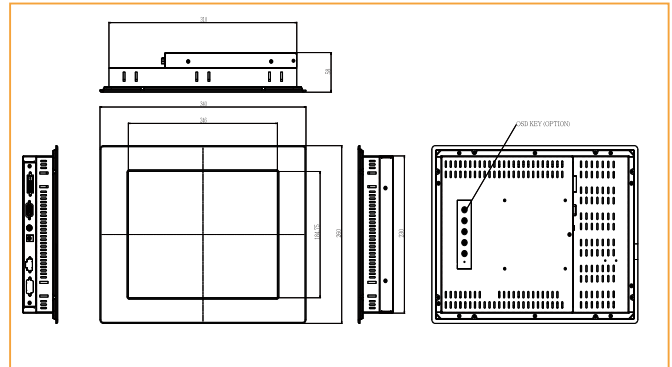

ISDM-150G

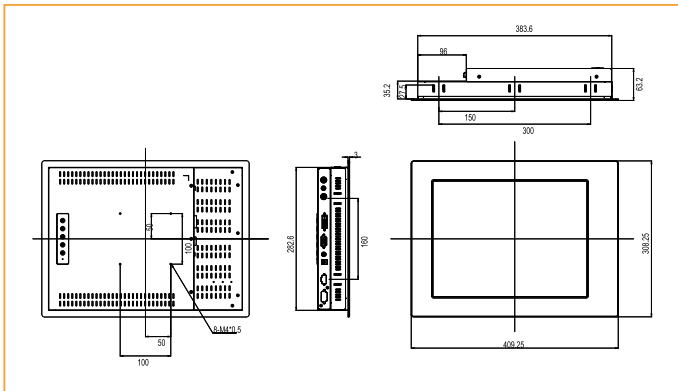

ISDM-170G

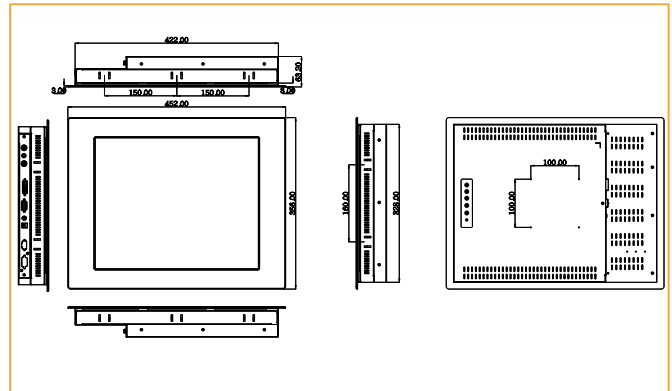

ISDM-190GS

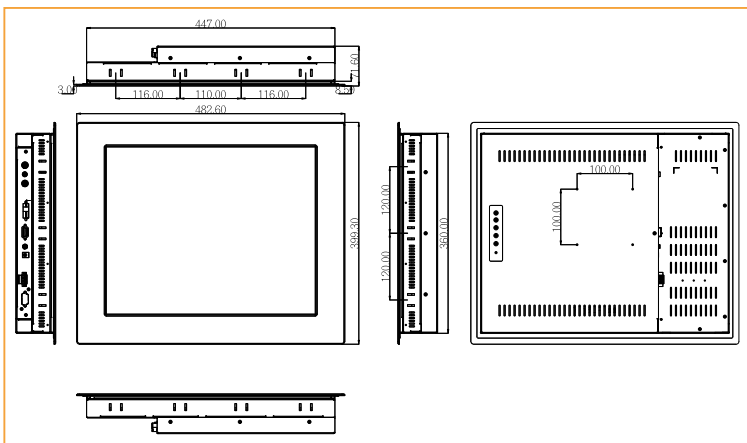

Packing List

Description
1 x AC Power Cable
1 x VGA Cable
1 x 45W AC Power Adapter (For ISDM-121G / 150G / 170G / 190G series)
1 x 25W AC Power Adapter (For ISDM-084GH / 104G series)
1 x User Manual
1 x Power Cable for Terminal Block (For M model ONLY)
1 x Touch Screen RS-232 Cable / Touch Pen / Driver CDROM (For T-R model ONLY)
1 x Touch Screen USB Cable / Touch Pen / Driver CDROM (For USB/T-R model)